

March 2015

PERSONAL INFORMATION

names **Vladimir Palankov**
address 3 Tennyson Road, Stratford, London E15 4DJ, UK
phone +44 7762 532 845
e-mail palankov@gmail.com
web www.palankov.com

Highly motivated professional, member of the Chamber of Architects in Bulgaria. License CAB No: 5034. Associate member of Architects Registration Board - Reg. No 084299K. Proficient in Revit Architecture, AutoCAD and Photoshop.



EDUCATION

2005 - 2011 **University of Architecture, Civil Engineering and Geodesy, Sofia, Bulgaria**
www.uacg.bg
academic degree Master of Architecture

07. 2010 **Erasmus intensive program Atoms & Bits Università Iuav di Venezia**
www.iuav.it
Certificate of successful participation
During IP Atoms & Bits, it was developed a future conceptual design solution of the Port of Marghera near Venice.

02. 2009 **Kanisco Ltd., Sofia, Bulgaria**
www.kanisco.com
AutoCAD Revit Architecture Suite Training Course Certificate

2000 - 2005 **Language School Dr. Ivan Bogorov, Dimitrovgrad, Bulgaria**
field of study English Language
academic degree Certificate of secondary education

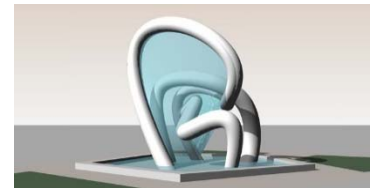
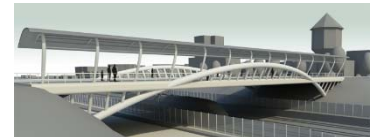

WORK EXPERIENCE

full portfolio designs www.palankov.com

06.2013 – present **All 1 Studio Ltd., Sofia**
www.all1studio.com
position freelance architect
activities design study, building design, 3D modeling

design **Urban Design Conception of Salon Island, Myanmar (3 square km, 12 400 exp. p)**
New Build

RIBA stages 0-2. Feasibility study and concept design



design **Car Service Building, Dryanovo, Bulgaria**
New Build (completely BIM)

RIBA stages 0-4. Feasibility study, concept design, design development, detailing, correspondence with the design team.



design **Residential House, Gabrovo, Bulgaria**
New Build (completely BIM)

RIBA stages 0-2. Feasibility study and concept design



design **Serial Design of Residential House**
New Build (completely BIM)

RIBA stages 0-4. Feasibility study, concept design, design development, detailing, correspondence with the design team.



design **Agricultural Aircraft Hangar, Gabrovo Municipality, Bulgaria**
New Build

RIBA stages 0-4. Feasibility study, concept design, design development, detailing, correspondence with the design team.

design **Welding Workshops and Warehouse, Gabrovo, Bulgaria**
New Build

RIBA stages 0-4. Feasibility study, concept design, design development, detailing, correspondence with the design team.

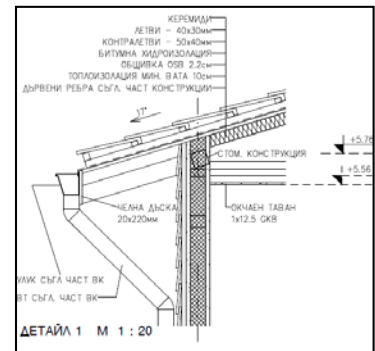

03.2013 – present **Proinvex Ltd., Sofia**
position architect
activities design study, building design

design **Fire Service Building, Levski, Bulgaria**
New Build

RIBA stages 0-4. Feasibility study, concept design, design development, detailing, correspondence with the design team.









08.2010 – 02.2013 **Tilev Architects Ltd., Sofia**
www.tilevarchitects.com
position architect
activities feasibility study, conceptual designs, technical designs, detailing, project management

design **Sopharma Ltd. – New Factory for Tablets, Storage and Services, Sofia, Bulgaria**
New Build

RIBA stages 0-6. As an associate. Feasibility study, concept design, design development, detailing, construction supervision

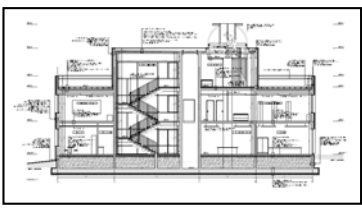

design	<p>Sopharma Ltd. – Laboratory and Service Complex, Sofia, Bulgaria New Build</p>	
RIBA stages	<p>0-6. As an associate. Feasibility study, concept design, design development, detailing, construction supervision</p>	
design	<p>Bank Office of UniCredit Bulbank Ltd., Sofia, Bulgaria Refurbishment</p>	
RIBA stages	<p>0-6. As an associate. Feasibility study, concept design, design development, detailing, correspondence with the design team</p>	
design	<p>Vasil Levski Primary School, German, Sofia Municipality, Bulgaria New Build</p>	
RIBA stages	<p>0-4. As an associate. Feasibility study, concept design, design development, detailing, correspondence with the design team</p>	
design	<p>Reconstruction of the Plenary of Bulgarian Parliament, Sofia, Bulgaria Refurbishment, Competition Design (Second Prize Winner)</p>	
RIBA stages	<p>0-2. As an associate. Feasibility study, concept design</p>	
design	<p>Astronomical Observatory and Planetarium, Burgas, Bulgaria New Build</p>	
RIBA stages	<p>0-4. As an associate. Feasibility study, concept design, design development, detailing, correspondence with the design team</p>	
design	<p>Conference Hall for UniCredit Bulbank Ltd., Sofia, Bulgaria Refurbishment, Interior Design</p>	
RIBA stages	<p>0-6. As an associate. Feasibility study, concept design, design development, detailing</p>	
design	<p>Bank Office of UniCredit Bulbank Ltd. in Paradise Center, Sofia, Bulgaria Refurbishment, Interior Design</p>	
RIBA stages	<p>0-6. As an associate. Feasibility study, concept design, design development, detailing</p>	
design	<p>Multifunctional Sports Complex Diana, Yambol, Bulgaria New Build and Refurbishment, Competition Design</p>	
RIBA stages	<p>0-2. As an associate. Feasibility study, concept design</p>	

07.2007 – 05.2010

Erta Consult Ltd., Sofia

www.ertaconsult.com

position
activities

intern architect
architectural design drawings, building design,
urban planning

design

**Master Plan of Maritsa Municipality, Bulgaria
(342 square km, 30 700 p)**

RIBA stages

As an associate. Feasibility study, concept
design, design development, correspondence
with the project team, documents preparation,
preparation of presentations.



design

**Kindergarten 170, Nadezhda District,
Sofia, Bulgaria**

New Build

RIBA stages

0-6. As an associate. Feasibility study,
concept design, design development, detailing



design

**Two Kindergartens in Lulin and Levski
District, Sofia, Bulgaria**

New Build

RIBA stages

0-6. As an associate. Feasibility study,
concept design, design development, detailing



PERSONAL SKILLS

technical skills

General computer literacy; MS Office, Open
Office, Adobe Acrobat Pro, Google Earth Pro.

	Basic	Independent	Proficient
Autodesk AutoCAD	8y		
Autodesk Revit	7y		
Adobe Photoshop	7y		
Adobe Illustrator	4y		
Google SketchUp	4y		
3ds Max Rendering	3y		

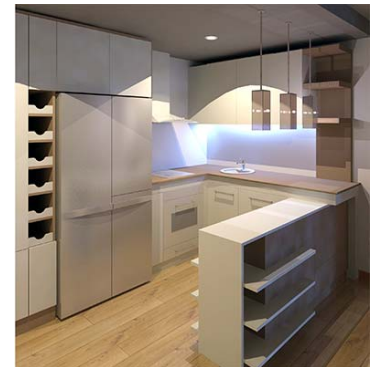

*Confident in applying skills in short period of time
in pressure situations. Responsible and
conscientious.
Use Building Information Modeling (BIM) as a basis
in architectural designing and drawing.*



languages

Bulgarian – native language

	Basic	Independent	Proficient
English			
German			
Russian			



driving license

B category, 03.2008

hobbies

hiking, bicycle riding, astronomy